	GENERAL SPECIFICATIONS	50-70-105-000_SPG_Capteur Tri_EN.docx	
	LoRaWAN 3-phase electric sensor	Rev: 4	Page 1/17

SPECIFICATIONS

LoRaWAN 3-phase electric sensor

Document revision history

DATE	REVISION	OBJECT	Author
02/21/2018	0	Creation	FV
02/03/2020	1	Additional information, for example frames	FV
03/05/2020	2	Wiring details added	FV
04/01/2020	3	Various corrections	FV
05/04/2020	4	Binary Input details added	FV
10/05/2020	5	Precision: non-recording index	FV
11/17/2020	6	Various corrections	FV

Controlled paper distribution:

--

	WRITTEN BY	APPROVED BY
NAME	Fabrice Vély	
POSITION	Project Manager	

CAUTION: unless otherwise stated (below), this is an uncontrolled copy of an electronic document. Refer to the nke Document Manager software for more information.

nke ☎ (33).02.97.36.10.12 Fax (33).02.97.36.55.17.. ..<http://www.nke.fr>

Model SPG.dot Rev1 of 14/12/04

	GENERAL SPECIFICATIONS	50-70-105-000_SPG_Capteur Tri_EN.docx	
	LoRaWAN 3-phase electric sensor	Rev: 4	Page 2/17

TABLE OF CONTENTS

1. OBJECT OF THE DOCUMENT	4
2. APPLICABLE DOCUMENTS - REFERENCE DOCUMENTS	4
3. DEFINITIONS – TERMINOLOGY	4
4. BACKGROUND AND OBJECTIVES OF THE STUDY	4
5. GENERAL STRUCTURE OF THE PRODUCT	4
6. FUNCTIONS OF THE PRODUCT IN INSTALLATION AND USE	5
6.1 PRODUCT PRESENTATION	5
6.1.1 <i>Housing</i>	5
6.1.2 <i>Human Machine Interface</i>	6
6.2 ON/OFF INPUT	8
6.3 ON/OFF OUTPUT	9
6.4 RS485 PORT (OPTION)	9
6.5 TIC BUS INPUT (OPTION)	9
6.6 VOLTAGE INPUTS	9
6.7 CURRENT INPUTS	10
6.7.1 <i>General remarks</i>	10
6.7.2 <i>Polarity</i>	11
6.7.3 <i>0-60 A range</i>	11
6.7.4 <i>0-400 A range</i>	11
6.7.5 <i>0-4000 A range</i>	11
6.8 CONNECTOR TECHNOLOGY	12
6.9 DATA TRANSMISSION	12
6.10 APPLICATION FUNCTIONS	12
6.11 EXAMPLES OF DATA EXCHANGES	12
6.11.1 <i>Report on voltage, current and phase measurements</i>	12
6.11.2 <i>Report on energy and power measurements</i>	12
6.11.3 <i>Report on on/off input state</i>	13
6.11.4 <i>Configuration frames</i>	13
6.11.5 <i>Sensor query and command</i>	14
6.12 OPERATING PARAMETERS	14
7. MANUFACTURABILITY	15
7.1 GENERAL REMARKS	15
7.2 PRODUCT MARKING	15
8. MAINTAINABILITY	15
9. DESIGN CONSTRAINTS	15
9.1 OPERATING TEMPERATURE AND HUMIDITY	15
9.2 STORAGE TEMPERATURE AND HUMIDITY	15
9.3 POWER SUPPLY	15
9.4 TIGHTNESS - IP RATING	15
9.5 AUTONOMY	16
9.6 RELIABILITY - SERVICE LIFE	16
9.7 MECHANICAL STRESS - SHOCKS - VIBRATIONS	16

CAUTION: unless otherwise stated (below), this is an uncontrolled copy of an electronic document. Refer to the nke Document Manager software for more information.

nke ☎ (33).02.97.36.10.12 Fax (33).02.97.36.55.17.. ..<http://www.nke.fr>

Model SPG.dot Rev1 of 14/12/04

	GENERAL SPECIFICATIONS	50-70-105-000_SPG_Capteur Tri_EN.docx	
	LoRaWAN 3-phase electric sensor	Rev: 4	Page 3/17

10. NORMATIVE REQUIREMENTS	16
10.1 ELECTROMAGNETIC COMPATIBILITY	16
10.2 ELECTRICAL SAFETY	16
10.3 ROHS DIRECTIVE	17
10.4 STANDARDS AND REGULATIONS SPECIFIC TO THE BUSINESS SEGMENT	17
11. MARKETING SPECIFICATIONS	17
11.1 PRODUCT SERVICE LIFE	17
11.2 PROJECTED QUANTITIES	17
11.3 PRICING STRUCTURE	17
11.4 GUARANTEE	17
11.5 MAINTENANCE	17
11.6 PRODUCT DOCUMENTATION REQUIREMENTS	17

CAUTION: unless otherwise stated (below), this is an uncontrolled copy of an electronic document. Refer to the nke Document Manager software for more information.

nke ☎ (33).02.97.36.10.12 Fax (33).02.97.36.55.17.. ..<http://www.nke.fr>

Model SPG.dot Rev1 of 14/12/04

	GENERAL SPECIFICATIONS	50-70-105-000_SPG_Capteur Tri_EN.docx	
	LoRaWAN 3-phase electric sensor	Rev: 4	Page 4/17

1. OBJECT OF THE DOCUMENT

Description of product, functions and expected characteristics.

2. APPLICABLE DOCUMENTS - REFERENCE DOCUMENTS

R1: ATL-EN-TIC project presentation

P:\Watteco\50-70-105-000_DE_Capteur_triphasé_LoRaWAN_868MHz\Spécifications\Projet_ATL-EN-TIC\PIAVE - ATL-EN-TIC - Présentation du projet - V4.pdf

R2: Detailed software specifications

50-70-105-000_SPG_Logicielles_Capteur_Tri.docx

R3: Enedis documents

Customer tele-information (TIC) output from electronic metering devices used by Enedis
https://www.enedis.fr/sites/default/files/Enedis-NOI-CPT_02E.pdf

Identification: Enedis-NOI-CPT_02E

Version: 6

R4: Online LoRa technical support

<http://support.nke-watteco.com>

Operational documentation for Watteco sensors

3. DEFINITIONS – TERMINOLOGY

ZCL-Like : Zigbee Cluster Library-Like. Application software library inspired by that established by the Zigbee consortium.

EP : End Point. Application port used by ZCL-Like.

HMI : Human-Machine Interface

TIC : Customer tele-information (Télé-Information Client). Data stream formats provided downstream of meters, as defined by ENEDIS (see R3)

4. BACKGROUND AND OBJECTIVES OF THE STUDY

The industry is seeking to reduce its energy consumption in order to increase its competitiveness. This national issue ultimately leads to the creation of tools designed to manage energy consumption. These tools include field measurement, radio transmission, data processing, analysis and action plans aimed at reducing consumption. For the partners of this project, the aim is to offer a comprehensive and open solution. In this context, nke provides its range of LoRaWAN sensors, which shall be supplemented by the three-phase sensor essential for the industry.

5. GENERAL STRUCTURE OF THE PRODUCT

The microcontroller on the board is an MSP430 with 256kB of flash memory.

The element used for measuring electrical quantities is the ADE9000 dedicated circuit from Analog Devices.

CAUTION: unless otherwise stated (below), this is an uncontrolled copy of an electronic document. Refer to the nke Document Manager software for more information.

nke ☎ (33).02.97.36.10.12 Fax (33).02.97.36.55.17.. ..<http://www.nke.fr>

Model SPG.dot Rev1 of 14/12/04

	GENERAL SPECIFICATIONS	50-70-105-000_SPG_Capteur Tri_EN.docx	
	LoRaWAN 3-phase electric sensor	Rev: 4	Page 5/17

Principle:

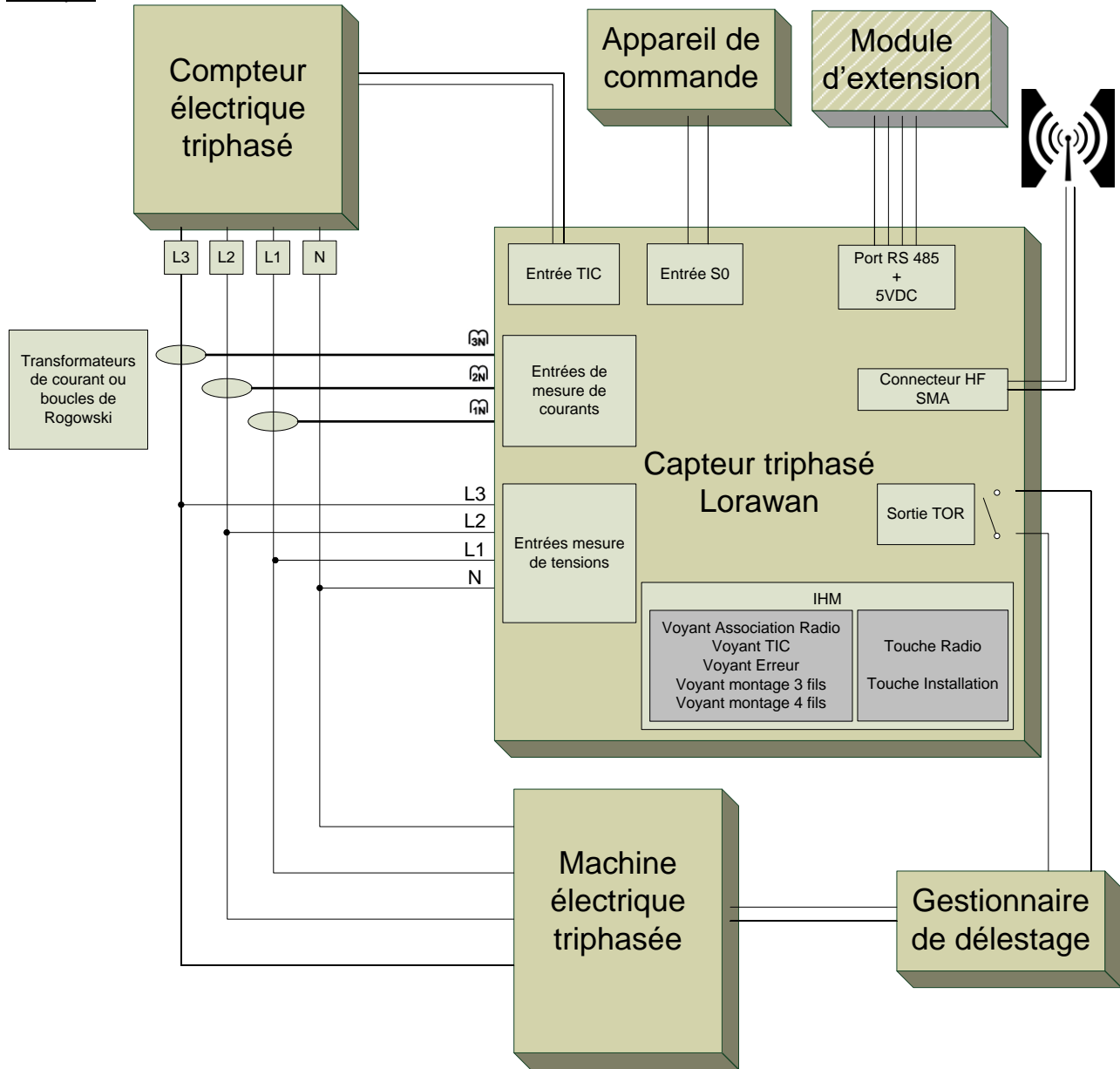

6. FUNCTIONS OF THE PRODUCT IN INSTALLATION AND USE

6.1 Product presentation

6.1.1 Housing

This sensor is mounted in a housing designed for 35mm DIN rail.
Width: 3 modules, i.e. 53.5mm.

CAUTION: unless otherwise stated (below), this is an uncontrolled copy of an electronic document. Refer to the nke Document Manager software for more information.

nke ☎ (33).02.97.36.10.12 Fax (33).02.97.36.55.17.. ..<http://www.nke.fr>

Model SPG.dot Rev1 of 14/12/04

	GENERAL SPECIFICATIONS	50-70-105-000_SPG_Capteur Tri_EN.docx	
	LoRaWAN 3-phase electric sensor	Rev: 4	Page 6/17

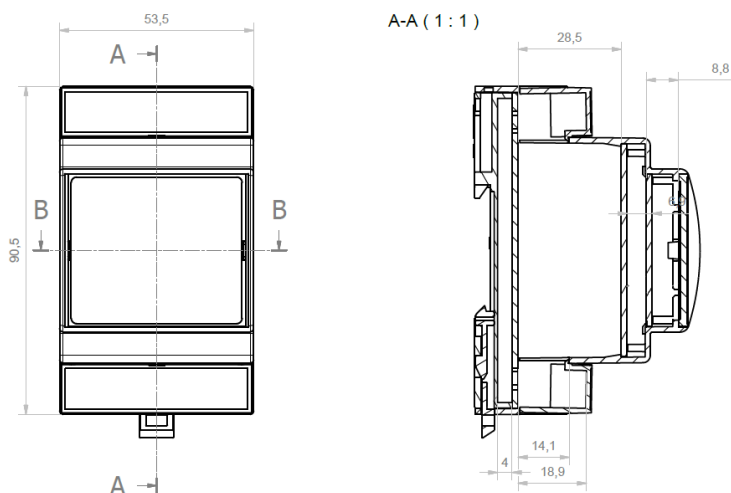

6.1.2 Human Machine Interface

6.1.2.1 Lights

There are 5 lights under the front panel glass

Allocation	Colour	Operation
Radio	Yellow	For more details, please refer to the detailed software specifications document
Tele-Information	Red	
Wiring error	Red	
4-wire configuration (star connection)	Green	
3-wire configuration (delta connection)	Green	

6.1.2.1.1 Detailed operation of the Tele-Information light

Light intensity greater than or equal to 1.8 mcd

The frequency of flashing requested for the flashing state of the indicator light must be 1Hz, since the indicator light is on for 0.5s and off for 0.5s (time intervals must be observed with an accuracy of 0.1s).

The decision of the receiving device as to the state of the indicator light must be effective once reception of the frame concerned is completed. The device then sets the state of the indicator light: permanently on or flashing.

This state must be kept identical until the next decision.

Consequently, when the indicator light is in the flashing state, this state must be maintained until the next complete reception of a correct frame. Likewise, when the indicator light is in the permanently on state, this state must be maintained until the next reception of an incorrect frame.

The light is off if there is no tele-information frame is received, it flashes if the frames received are incorrect and permanently on if the reception is correct.

Please refer to the Enedis documentation for more details.

6.1.2.2 Keys

The 2 keys are flush with the glass and are allow the product's radio and hardware configuration

6.1.2.2.1 Radio key

Standard operation

- Short press: start/stop configuration mode
- 3 short presses: start re-pairing mode
- 2 short presses and 1 long press (approximately 7 seconds): factory reset

CAUTION: unless otherwise stated (below), this is an uncontrolled copy of an electronic document. Refer to the nke Document Manager software for more information.

nke ☎ (33).02.97.36.10.12 Fax (33).02.97.36.55.17.. ..http://www.nke.fr

Model SPG.dot Rev1 of 14/12/04

	GENERAL SPECIFICATIONS	50-70-105-000_SPG_Capteur Tri_EN.docx	
	LoRaWAN 3-phase electric sensor	Rev: 4	Page 7/17

- 1 long press (approximately 5 seconds): switch to storage mode

For more details, please refer to the detailed software specifications document

6.1.2.2.2 Electrical configuration key

This key is used to configure the sensor in the appropriate type of installation.

- "4-wire" type installation, or
- "3-wire" type installation, or
- single-phase installation.

With each press, the sensor switches between the three modes.

To tell the installer which mode the sensor is in, the latter will switch on:

- the "4-wire configuration" LED only (4-wire mode), or
- the "3-wire configuration" LED only (3-wire mode), or
- these 2 LEDs simultaneously (single-phase mode).

For more details, please refer to the detailed software specifications document

6.1.2.3 Antenna connection

A female SMA connector is mounted on the front panel to allow the connection of an antenna or an extension for a remote antenna.

6.1.2.4 Markings

6.1.2.4.1 Glass

The glass includes markings that identify each light and each key with a logo or short text. The nke Watteco logo is also present on the glass.

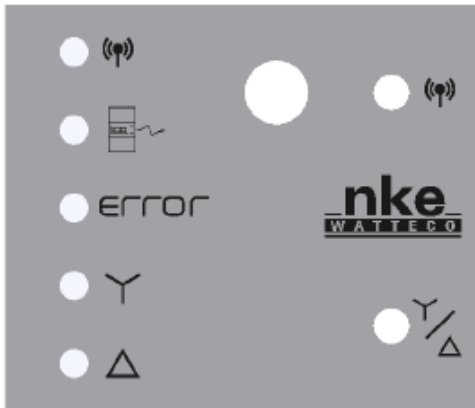

6.1.2.4.2 Connector technology

The box bears a marking to identify each terminal block.

CAUTION: unless otherwise stated (below), this is an uncontrolled copy of an electronic document. Refer to the nke Document Manager software for more information.

nke ☎ (33).02.97.36.10.12 Fax (33).02.97.36.55.17.. ..<http://www.nke.fr>

Model SPG.dot Rev1 of 14/12/04

	GENERAL SPECIFICATIONS	50-70-105-000_SPG_Capteur Tri_EN.docx	
	LoRaWAN 3-phase electric sensor	Rev: 4	Page 8/17

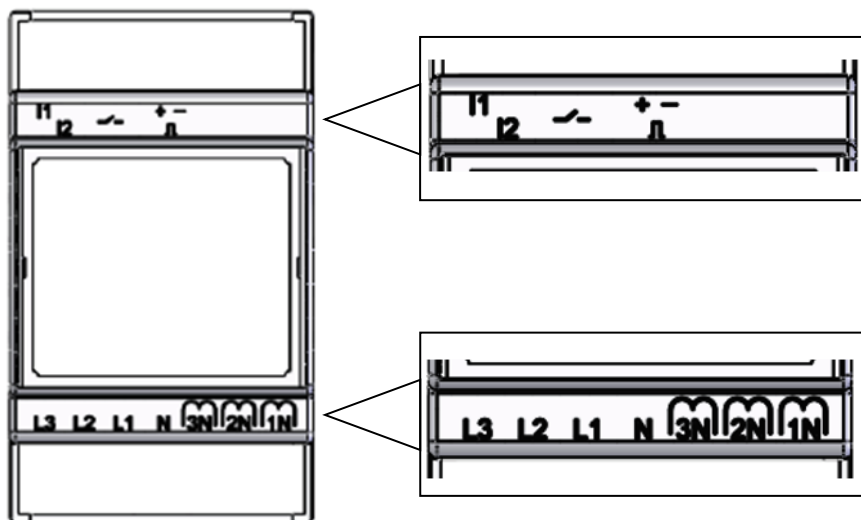

6.2 On/Off input

Input controlled:

- by a dry contact: pinching at the input ground, 10kΩ maximum contact resistance at ground.
- by $0 < V_{IL} < 0.5V_{DC}$ to deactivate the input and $2.5V_{DC} < V_{IH} < 30V_{DC}$ to activate the input (10kΩ of serial protection beyond 5V_{DC}).

The terminal marked on the housing corresponds to the ground on the board.
Overvoltage protection.

Input connection to a dry contact:

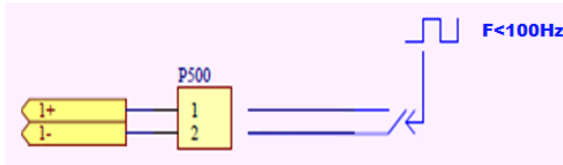

The dry contact must take into account the low polarization current of the input. The use of a silver- or gold-plated contact is recommended to ensure the state is properly detected.

Input connection to a square signal:

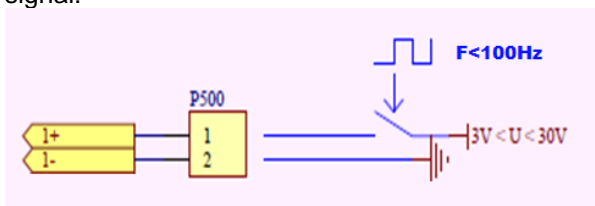

Example using a polarized connector:

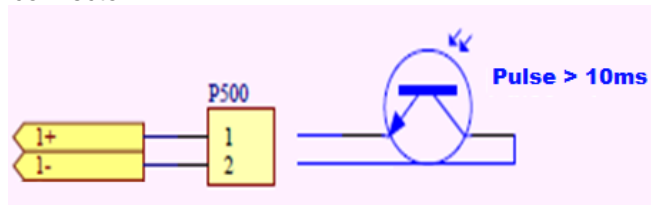

This shows a phototransistor as an example. The same is true for other types of polarized connectors.

CAUTION: unless otherwise stated (below), this is an uncontrolled copy of an electronic document. Refer to the nke Document Manager software for more information.

	GENERAL SPECIFICATIONS	50-70-105-000_SPG_Capteur Tri_EN.docx	
	LoRaWAN 3-phase electric sensor	Rev: 4	Page 9/17

6.3 On/Off output

Electromechanical relay, 10kV insulation between the coil and the contacts.
 Breaking capacity of 1A @ 230V_{RMS} under purely resistive load.
 Minimum current: 10mA @ 5V_{DC}
 Make contact, normally open.
 Potential free, dry contact.

This output must be protected from overcurrents by an external device with a rating suited to the output capacity.

Function: status report (fault, deletion...)

6.4 RS485 port (option)

The Triphas'O sensor includes a component that allows RS485 communication from a UART link. It enables half-duplex communication (the ModBus protocol as defined does not need full duplex).

The communication speed on the RS485 link is limited by the UART of the MCU. Its upper limit is 460.8kbps. In addition, the ModBus link developed is RTU compatible only.

Communication parameters can be configured remotely using the remote server. These parameters are: speed, parity, number of data bits and number of stop bits.

In addition, an end of line resistor (120 Ω) can be activated to suppress signal reflection as much as possible. The resistor is activated or deactivated by moving the slide of a switch during installation.

The RS485 port is equipped with a point of supply: 5V_{DC} for I_{MAX} = 30mA

6.5 TIC bus input (option)

Objective: detection and reading of the TIC data generated by ENEDIS meters (except the PME-PMI meter which uses an RS232 link).

General transmission characteristics

- a. Binary transmission
- b. Unidirectional transmission mode
- c. Amplitude modulation on a carrier at 50 kHz ± 3%
- d. Modulation speed:
 - 1200 bauds ± 1% (all metering devices except SAPHIR)
 - 1200 bauds ± 1% or 9600 Bauds ± 1% (SAPHIR meter only)
- e. Bit duration equal to "0" and "1"
- f. Negative coding logic:
 - carrier presence is equivalent to a "0" bit
 - carrier absence is equivalent to a "1" bit.

6.6 Voltage inputs

Each voltage input is equipped with a stage that allows the voltage to be reduced to a level compatible with the ADE9000 input stage.

Maximum voltage: 500V_{RMS}
 Measurement accuracy: 1%

Quantity: 4 (Neutral and 3 phases)

CAUTION: unless otherwise stated (below), this is an uncontrolled copy of an electronic document. Refer to the nke Document Manager software for more information.

In the case of a star-type installation (4 wires), the neutral is present, hence the 4 points are used.

Phase	Terminal block
Phase 1	L1
Phase 2	L2
Phase 3	L3
Neutral	N

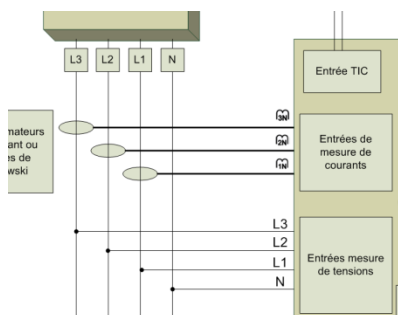

In the case of a delta-type installation (3 wires), there is no neutral, hence only 3 points are used.

Phase	Terminal block
Phase 1	L1
Phase 2	N
Phase 3	L3

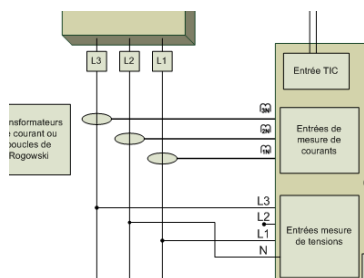

In the case of a single-phase installation, only 2 points are used.

Phase	Terminal block
Phase	L1
Neutral	N

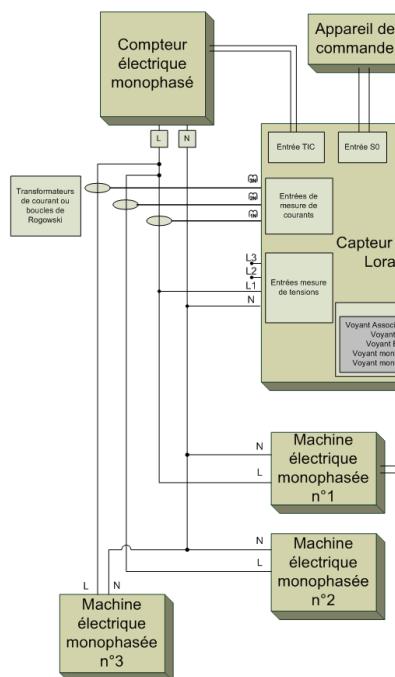

6.7 Current inputs

6.7.1 General remarks

There are 3 current inputs.

In the case of a star-type installation, the 3 inputs are used.

In the case of a delta-type installation, the current in phase 2 is obtained by difference from the other 2. Only measurement points 1 and 3 are used.

CAUTION: unless otherwise stated (below), this is an uncontrolled copy of an electronic document. Refer to the nke Document Manager software for more information.

nke (33).02.97.36.10.12 Fax (33).02.97.36.55.17...http://www.nke.fr

Model SPG.dot Rev1 of 14/12/04

	GENERAL SPECIFICATIONS	50-70-105-000_SPG_Capteur Tri_EN.docx	
	LoRaWAN 3-phase electric sensor	Rev: 4	Page 11/17

6.7.2 Polarity

In order to correctly measure the angle between voltage and current, the polarity must be observed when connecting current transformers. The 2 wires of the secondary circuit must be connected so as to be in the same direction as the primary current. In the event of an error, the phase measurement will be shifted by 180°.



The arrow indicates the direction of polarity to be observed, as per that on the primary of the current transformer.

6.7.3 0-60 A range

Primary current transformation by a current transformer with a 1:3000 ratio @ 50 Hz (supplied)
Measurement accuracy: 3% of full scale (with a Class 2 current transformer)

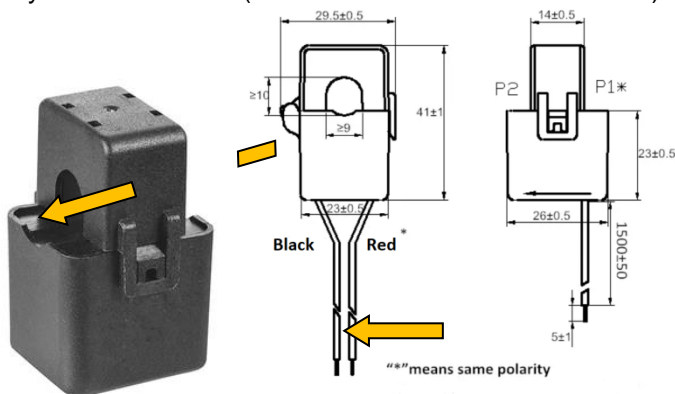

60 A transformer:

6.7.4 0-400 A range

Primary current transformation by a current transformer with a 1:5000 ratio @ 50Hz (supplied)

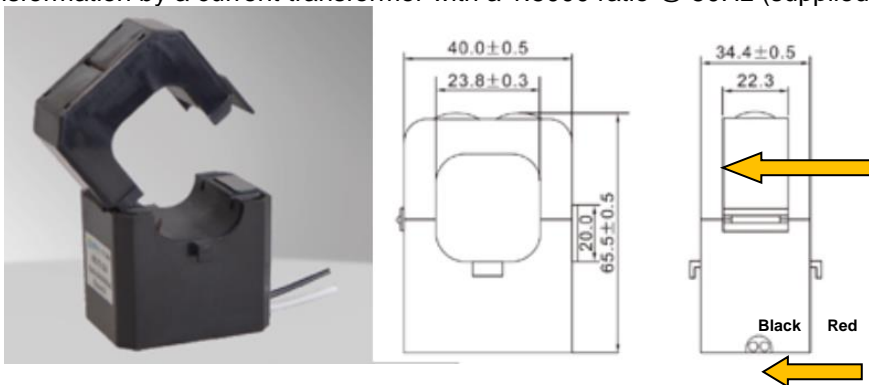

400 A transformer:

Measurement accuracy: 2% of full scale (with a Class 1 current transformer)

6.7.5 0-4000 A range

Transformation of the primary current by a Rogowski coil with a ratio of 22.5 mV/kA @ 50 Hz (not supplied)



Example of coil:



Measurement accuracy: 1.5% of full scale (with a Class 0.5 Rogowski coil)

CAUTION: unless otherwise stated (below), this is an uncontrolled copy of an electronic document. Refer to the nke Document Manager software for more information.

	GENERAL SPECIFICATIONS	50-70-105-000_SPG_Capteur Tri_EN.docx	
	LoRaWAN 3-phase electric sensor	Rev: 4	Page 12/17

6.8 Connector technology

Consists of spring-loaded terminal blocks.

Function	Pitch (mm)	Number of points	Marking	Cross-section (mm ²)	Unpluggable
On/Off input	3.5	2		0.518-2.08	No
On/Off output	3.5	2		0.518-2.08	No
RS485 port (option)	3.5	4	None	0.518-2.08	No
TIC input (option)	3.5	2	I1, I2	0.518-2.08	No
Voltage input	7.0	4	L1, L2, L3, N	0.050-1.31	No
Current input	3.5	4		0.200-1.50	Yes

6.9 Data transmission

Data transmission is carried out using a LoRa radio solution that allows data transfer over long distances with a very low transmission rate.

Remote access to data and parameters is consistent with the existing operating mode of Watteco sensors. It is implemented using the "ZCL-like" application layer (see *Operational documentation for Watteco sensors*). Although inspired by the "Zigbee™" application specifications, the ZCL implemented by Watteco sensors contains numerous advances that help optimise the exchanges and functionalities made available to users.

6.10 Application functions

Please refer to the detailed software specifications document

6.11 Examples of data exchanges

Each phase corresponds to an endpoint:

- Phase A: 11
- Phase B: 31
- Phase C: 51
- Sum of the 3 phases: 71

6.11.1 Report on voltage, current and phase measurements

11 0a 80 0b 0000 41 06 09 0d 00 00 01 67

11 : Phase A

09 0d : Voltage in 1/10th V 0x090d = 2317 ≡ 231.7V

00 66 : Current in 1/10th A 0x0066 = 102 ≡ 10.2A

01 67 : Angle (degree) between voltage and current 0x0167 = 359° = -1°

6.11.2 Report on energy and power measurements

71 0a 80 0a 0000 41 20 0000103c00000001000000000000016000009370000000000000000000000c

71 : Phase A + Phase B + Phase C

0000103c : Positive active energy 4156 Wh

00000001 : Negative active energy 1 Wh

00000000 : Positive reactive energy 0 VARh

00000016 : Negative reactive energy 22 VARh

00000937 : Positive active power 2359 W

00000000 : Negative active power 0 W

00000000 : Positive reactive power 0 VAR

0000000c : Negative reactive power 12 VAR

Resetting energy meters:

51 50 80 0a 00

51 : Phase C

CAUTION: unless otherwise stated (below), this is an uncontrolled copy of an electronic document. Refer to the nke Document Manager software for more information.

nke ☎ (33).02.97.36.10.12 Fax (33).02.97.36.55.17.. ..http://www.nke.fr

Model SPG.dot Rev1 of 14/12/04

 W A T T E C O	GENERAL SPECIFICATIONS	50-70-105-000_SPG_Capteur Tri_EN.docx	
	LoRaWAN 3-phase electric sensor	Rev: 4	Page 13/17

Important note: Energy meters are not recorded by the sensor. They are transmitted and it is therefore up to the processing platform to save them.

6.11.3 Report on on/off input state

11 0a 00 0f 00 55 10 01

11 : On/Off input (End Point 0)

01 : Active state

6.11.4 Configuration frames

6.11.4.1 Report of voltage, current and angle

Cluster: VoltageCurrentMetering

1106800B000000410000803C06000000000000

0000 : Min Report = 0 (hence no min report)

803C : Max Report = 80 00 || 00 3C with 00 3C = 60 minutes = 1 hr

0000 : Variation on voltage (1/10th V) to trigger a report (0 = no report on variation)

0000 : Variation on current (1/10th V) to trigger a report

0000 : Variation on angle to trigger a report

Sensor response: **1107800b00000000**

6.11.4.2 Time basis for mean power calculation

Cluster: EnergyPowerMetering

1105800A00012300000E10

0E 10 : Time basis for mean power calculation 0E10 = 3600 seconds = 1 hr

Sensor response: an EnergyPowerMetering report

Type: **110a800a00004120000018c600000000000000000000000000001f000009af0000000000000000000000000c**

6.11.4.3 Report on energy and power values

Cluster: EnergyPowerMetering

1106800A000000410000803C2000000000 00

0000 : Min Report = 0 (hence no min report)

803C : Max Report = 80 00 || 00 3C with 00 3C = 60 minutes = 1 hr

00000000 : Variation on positive active energy (Wh) to trigger a report (0 = no report on variation)

00000000 : Variation on negative active energy (Wh) to trigger a report

00000000 : positive reactive energy (VARh)

00000000 : negative reactive energy (VARh)

00000000 : Variation on positive active power (W) to trigger a report

00000000 : negative active power (W)

00000000 : positive reactive power (VAR)

00000000 : negative reactive power (VAR)

Sensor response: **1107800A00000000**

6.11.4.4 On/Off input state report

11 06 00 0f 00 00 55 10 80 00 80 10 01

80 00 : immediate transmission in case of state variation

80 10 : maximum report (= 10 minutes). This allows a report to be issued on start-up to know the state of the input during installation. With **FF FF**: no report during the period.

01 : report on change of state

Sensor response: **1107000F00000055**

CAUTION: unless otherwise stated (below), this is an uncontrolled copy of an electronic document. Refer to the nke Document Manager software for more information.

nke ☎ (33).02.97.36.10.12 Fax (33).02.97.36.55.17.. ..<http://www.nke.fr>

Model SPG.dot Rev1 of 14/12/04

	GENERAL SPECIFICATIONS	50-70-105-000_SPG_Capteur Tri_EN.docx	
	LoRaWAN 3-phase electric sensor	Rev: 4	Page 14/17

6.11.5 Sensor query and command

6.11.5.1 Voltage, current and angle reading:

Cluster: VoltageCurrentMetering

Example: End Point 2 (Phase C)

5100800B0000

Response: **510180b0000004106095600690167**

09 56 : Voltage in 1/10th V 0x0956 = 2390 \equiv 239.0V

00 69 : Current in 1/10th A 0x0069 = 105 \equiv 10.5A

01 67 : Angle (degree) between voltage and current 0x0167 = 359° = -1°

6.11.5.2 Reading of energy meters and mean power:

Cluster: EnergyPowerMetering

Example: End Point 3 (Phase ABC)

7100800A0000

Response: **7101800a000000412000004c2a00000000000000000000060000009830000000000000000000000b**

00004c2a : Positive active energy 19 498 Wh

00000000 : Negative active energy 0 Wh

00000000 : Positive reactive energy 0 VARh

00000060 : Negative reactive energy 96 VARh

00000983 : Positive active power 2435 W

00000000 : Negative active power 0 W

00000000 : Positive reactive power 0 VAR

0000000b : Negative reactive power 11 VAR

6.11.5.3 Query on the On/Off input state

Cluster: Binary Input

Example: End Point 0

11000 0F0055

Response: **1101000f0055001001**

11 : On/Off input (End Point 0)

01 : Active state

6.11.5.4 On/Off output command

Cluster: On/Off

Example: End Point 0

1150000600 Dry contact opening

1150000601 Dry contact closing

1150000602 Dry contact state reversal

6.12 Operating parameters

Please refer to the detailed software specifications document

Default configuration:

Report on voltage, current and angle: 1 hr period (no report on variation)

Report on energy meters and mean power: 1 hr period (no report on variation)

Calculation of mean power values over 1 hour

CAUTION: unless otherwise stated (below), this is an uncontrolled copy of an electronic document. Refer to the nke Document Manager software for more information.

nke ☎ (33).02.97.36.10.12 Fax (33).02.97.36.55.17.. ..<http://www.nke.fr>

Model SPG.dot Rev1 of 14/12/04

	GENERAL SPECIFICATIONS	50-70-105-000_SPG_Capteur Tri_EN.docx	
	LoRaWAN 3-phase electric sensor	Rev: 4	Page 15/17

7. MANUFACTURABILITY

7.1 General remarks

The components used in the making of the electronics must be easy to procure and the board must include as many CMS-type components as possible (with the exception of connector technology and electrical safety components, for example).

The design of the electronics must also take into account the production side. In particular, easy access to the microcontroller for programming, as well as test probes or a self-test sufficiently efficient to detect any type of fault on the electronic board.

7.2 Product marking

CE and WEEE markings embossed on the plastic element.

An NFC label (144 bytes / 13.56 Mhz / NFC Forum Type 2 / ISO 14443 A) is affixed behind the glass inside the product and can be accessed using a standard reader (smartphone type). This label allows the installer to retrieve the information required to configure the product. A marking (embossed on the plastic element) identifies the NFC label.

A thermal paper label is affixed on the outside for production tracking and to offer the installer a manual method to retrieve the information he/she needs (smartphone unavailable or other similar case).

Label content:

Field	Example
Product designation	Triphas'O
nke family code	50-70-105-xxx
MAC Address (DevEUI)	5E :FF:56:A2:AF:15:DA:68
Year/Week of manufacture	19/W37
QR code (nke family code + DevEUI)	
nke MO No. (for the DB)	

8. MAINTAINABILITY

No provision is made at the factory for on-site troubleshooting of installed products.

9. DESIGN CONSTRAINTS

9.1 Operating temperature and humidity

-20°C to +55°C

9.2 Storage temperature and humidity

-30°C to +60°C

9.3 Power supply

Mains input: 100-450VAC - 47-70Hz

Sensor L1 and L2 terminals.

The sensor thus uses phase 1 and neutral (star connection) or phase 1 and phase 2 (delta connection) as power source.

9.4 Tightness - IP rating

IP20

CAUTION: unless otherwise stated (below), this is an uncontrolled copy of an electronic document. Refer to the nke Document Manager software for more information.

nke ☎ (33).02.97.36.10.12 Fax (33).02.97.36.55.17.. ..http://www.nke.fr

Model SPG.dot Rev1 of 14/12/04

	GENERAL SPECIFICATIONS	50-70-105-000_SPG_Capteur Tri_EN.docx	
	LoRaWAN 3-phase electric sensor	Rev: 4	Page 16/17

9.5 Autonomy

Not applicable

9.6 Reliability - Service life

10 years in operation.

9.7 Mechanical stress - shocks - vibrations

10. **NORMATIVE REQUIREMENTS**

10.1 Electromagnetic compatibility

The product must comply with the standards and directives applicable for the CE marking. nke will provide the EU certificate of conformity.

Compliance must be ensured with the requirements related to:

- immunity to electromagnetic interference at radio frequencies
- radiated and conducted emissions

as per:

- NF EN 55014-1 (April 2007)
Classification index: C91-014-1
ICS section(s): 33.100.10
Title: Electromagnetic compatibility - Requirements for household appliances, electric tools and similar apparatus - Part 1: Emission.
- NF EN 55014-2 (July 2015)
Classification index: C91-014-2
ICS section(s): 33.100.20, 97.030
Title: Electromagnetic compatibility - Requirements for household appliances, electric tools and similar apparatus - Part 2: Immunity. Product family standard and amendment
- NF EN 61000-6-1 (March 2007)
Classification index: C91-006-1
ICS section(s): 33.100.20
Title: Electromagnetic compatibility (EMC) - Part 6-1: Generic standards - Immunity standard for residential, commercial and light-industrial environments
- NF EN 61000-6-3 (March 2007)
Classification index: C91-006-3
ICS section(s): 33.100.10
Title: Electromagnetic compatibility (EMC) - Part 6-3: Generic standards - Emission standard for residential, commercial and light-industrial environments
- DI 2014/30/EU (February 2014)
Status: Directive
Title: Directive on the harmonisation of the laws of the Member States relating to electromagnetic compatibility

10.2 Electrical Safety

NF EN 60950-1 September 2006

Information technology equipment - Safety - Part 1: General requirements

DI 2014/35/EU (February 2014)

CAUTION: unless otherwise stated (below), this is an uncontrolled copy of an electronic document. Refer to the nke Document Manager software for more information.

nke  (33).02.97.36.10.12 Fax (33).02.97.36.55.17.. ..http://www.nke.fr

Model SPG.dot Rev1 of 14/12/04

	GENERAL SPECIFICATIONS	50-70-105-000_SPG_Capteur Tri_EN.docx	
	LoRaWAN 3-phase electric sensor	Rev: 4	Page 17/17

Status: Directive

Title: Directive on the harmonisation of the laws of the Member States relating to the making available on the market of electrical equipment designed for use within certain voltage limits

10.3 RoHS Directive

nke will provide the RoHS certificate for these products.

10.4 Standards and regulations specific to the business segment

EN 300 220-2 V2.4.1 (2012-05)

Electromagnetic compatibility and Radio spectrum Matters (ERM); Short Range Devices (SRD); Radio equipment to be used in the 25 MHz to 1 000 MHz frequency range with power levels ranging up to 500 mW; Part 2: Harmonized EN covering essential requirements under article 3.2 of the R&TTE Directive.

http://www.etsi.org/deliver/etsi_en/300200_300299/30022002/02.04.01_60/en_30022002v020401p.pdf

EN 301 489-3 V1.6.1 (2013-08)

Electromagnetic compatibility and Radio spectrum Matters (ERM); ElectroMagnetic Compatibility (EMC) standard for radio equipment and services;

Part 3: Specific conditions for Short-Range Devices (SRD) operating on frequencies between 9 kHz and 246 GHz

11. MARKETING SPECIFICATIONS

11.1 Product service life

10 years

11.2 Projected quantities

11.3 Pricing structure

See applicable offers

11.4 Guarantee

2 years, parts and labour

11.5 Maintenance

See above, except for possible factory resetting

11.6 Product documentation requirements

To be specified by nke

CAUTION: unless otherwise stated (below), this is an uncontrolled copy of an electronic document. Refer to the nke Document Manager software for more information.

nke ☎ (33).02.97.36.10.12 Fax (33).02.97.36.55.17.. ..<http://www.nke.fr>

Model SPG.dot Rev1 of 14/12/04